

2.5W FILTERLESS CLASS-D MONO AUDIO AMPLIFIER

Description

The PAM8302A is a 2.5W Class-D mono audio amplifier. Its low THD+N feature offers high quality sound reproduction. The new filter less architecture allows the device to drive speakers directly instead of using low-pass output filters, therefore saving system cost and PCB area.

With the same number of external components, the efficiency of the PAM8302A is much better than that of Class-AB cousins. It can optimize battery life thus is ideal for portable applications.

The PAM8302A is available in MSOP-8, SO-8 and U-DFN3030-8 packages.

Features

- 2.5W Output at 10% THD with a 4Ω Load and 5V Power Supply
- Filterless, Low Quiescent Current and Low EMI
- High Efficiency up to 88%
- Superior Low Noise
- Short Circuit Protection
- Thermal Shutdown
- Few External Components to Save Space and Cost
- MSOP-8, SO-8 and U-DFN3030-8 Packages Available
- Lead Free and Green Devices Available (RoHS Compliant)
- **Totally Lead-Free & Fully RoHS Compliant (Notes 1 & 2)**
- **Halogen and Antimony Free. "Green Device (Note 3)**

Applications

- PMP/MP4
- GPS
- Portable Speakers
- 2-Way Radios
- Hands-Free Phones/Speaker Phones
- Cellular Phones

Pin Assignments

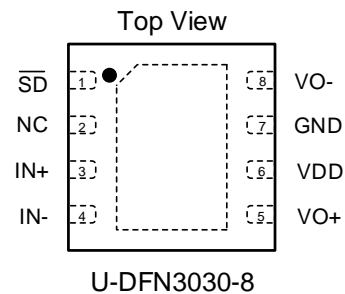
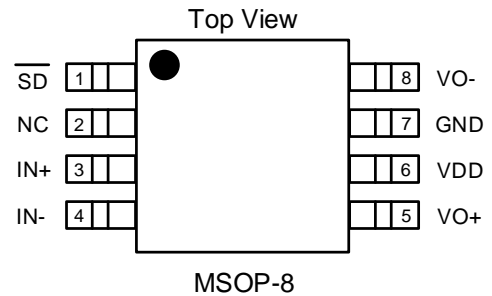
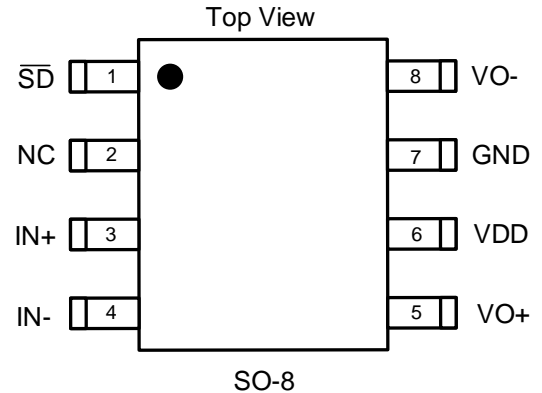

Notes: 1. No purposely added lead. Fully EU Directive 2002/95/EC (RoHS) & 2011/65/EU (RoHS 2) compliant.
 2. See http://www.diodes.com/quality/lead_free.html for more information about Diodes Incorporated's definitions of Halogen- and Antimony-free, "Green" and Lead-free.
 3. Halogen- and Antimony-free "Green" products are defined as those which contain <900ppm bromine, <900ppm chlorine (<1500ppm total Br + Cl) and <1000ppm antimony compounds.

Typical Applications Circuit

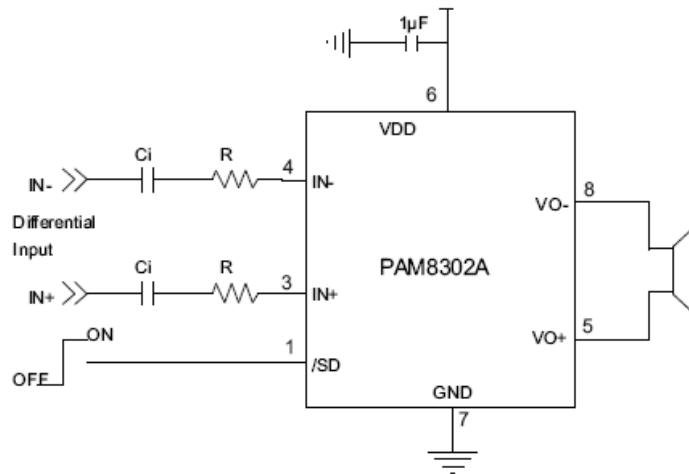

Functional Block Diagram

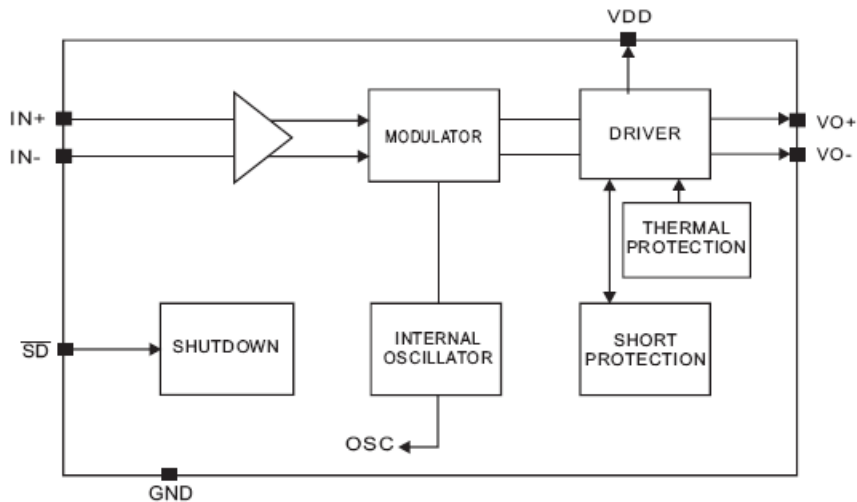

Absolute Maximum Ratings (@T_A = +25°C, unless otherwise specified.)

These are stress ratings only and functional operation is not implied. Exposure to absolute maximum ratings for prolonged time periods may affect device reliability. All voltages are with respect to ground.

Parameter	Rating	Unit
Supply Voltage at No Input Signal	6.0	V
Input Voltage	-0.3 to V _{DD} +0.3	
Maximum Junction Temperature	+150	°C
Storage Temperature	-65 to +150	
Soldering Temperature	300, 5sec	

Recommended Operating Conditions (@T_A = +25°C, unless otherwise specified.)

Parameter	Rating	Unit
Supply Voltage Range	2.0 to 5.5	V
Operation Temperature Range	-40 to +85	°C
Junction Temperature Range	-40 to +125	°C

Thermal Information

Parameter	Package	Symbol	Max	Unit
Thermal Resistance (Junction to Ambient)	SO-8	θ_{JA}	115	°C/W
	MSOP-8		180	
	U-DFN3030-8		47.9	

Electrical Characteristics (@T_A = +25°C, V_{IN} = 3.6V, V_O = 1.8V, C_{IN} = 10μF, C_{OUT} = 10μF, L = 4.7μH, unless otherwise specified.)

Parameter	Symbol	Test Conditions	Min	Typ	Max	Units	
Supply Voltage Range	V _{DD}	—	2.0		5.5	V	
Quiescent Current	I _Q	No Load	—	4	8	mA	
Shutdown Current	I _{SHDN}	V _{SHDN} = 0V	—	—	1	μA	
Output Power	P _O	f = 1kHz, R _L = 4Ω, THD+N = 10%	V _{DD} = 5V	2.25	2.50	—	W
			V _{DD} = 3.6V	1.10	1.25	—	
		f = 1kHz, R _L = 4Ω, THD+N = 1%	V _{DD} = 5V	1.80	2.00	—	
			V _{DD} = 3.6V	0.86	0.95	—	
		f = 1kHz, R _L = 8Ω, THD+N = 10%	V _{DD} = 5V	1.35	1.50	—	
			V _{DD} = 3.6V	0.72	0.80	—	
Peak Efficiency	η	f = 1kHz	V _{DD} = 5V	—	85	88	%
			V _{DD} = 3.6V	—	—	—	—
Total Harmonic Distortion Plus Noise	THD+N	R _L = 8Ω, P _O = 0.1W, f = 1kHz	—	0.30	0.35	%	
		R _L = 8Ω, P _O = 0.5W, f = 1kHz	—	0.45	0.50		
		R _L = 4Ω, P _O = 0.1W, f = 1kHz	—	0.35	0.40		
		R _L = 4Ω, P _O = 0.5W, f = 1kHz	—	0.40	0.45		
Gain	G _V	—	22.5	24.0	25.5	dB	
Power Supply Ripple Rejection	PSRR	No Inputs, f = 1kHz, V _{PP} = 200mV	45	50	—	dB	
Dynamic Range	DYN	f = 20 to 20kHz	85	90	—	dB	
Signal to Noise Ratio	SNR	f = 20 to 20kHz	75	80	—	dB	
Noise	V _N	No A-Weighting	—	180	300	μV	
		A-Weighting	—	120	200		
Oscillator Frequency	f _{OSC}	—	200	250	300	kHz	
Drain-Source On-State Resistance	R _{DS(ON)}	I _{DS} = 100mA	P MOSFET	—	0.45	0.50	Ω
			N MOSFET	—	0.20	0.25	
$\overline{\text{SHDN}}$ Input High	V _{SH}	—	—	1.2	—	V	
$\overline{\text{SHDN}}$ Input Low	V _{SL}	—	—	—	0.4		
Over Temperature Protection	OTP	Junction Temperature	+120	+135	—	°C	
Over Temperature Hysteresis	OTH	—	—	+30	—	°C	

Typical Performance Characteristics (@ $T_A = +25^\circ\text{C}$, unless otherwise specified.)

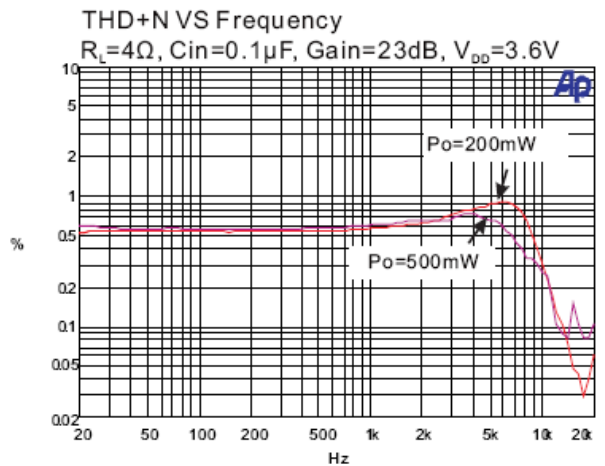
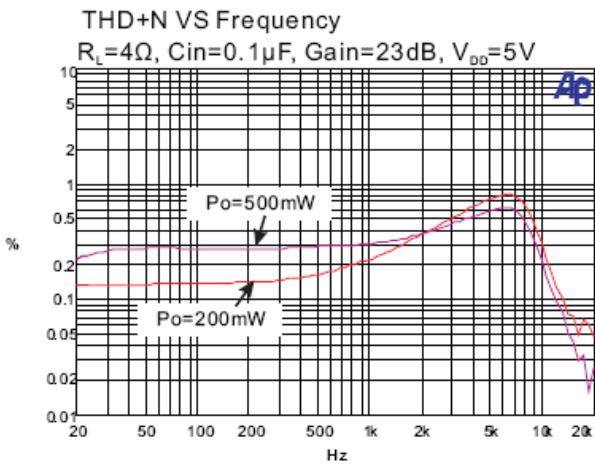
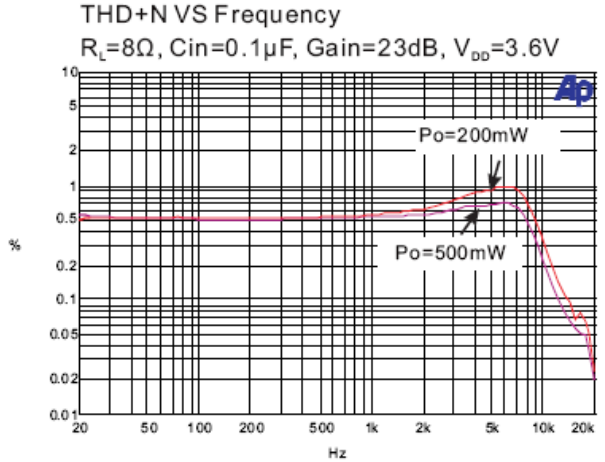
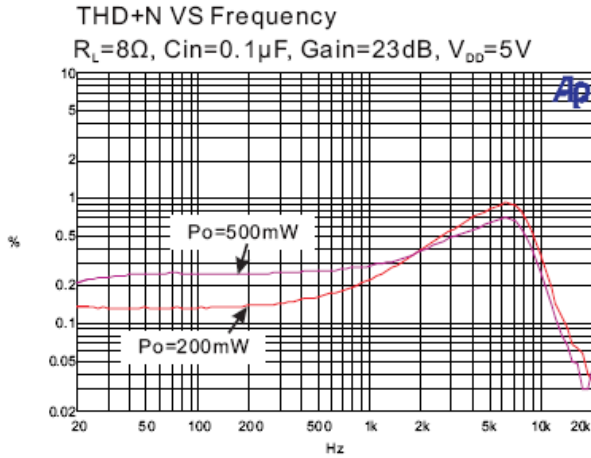
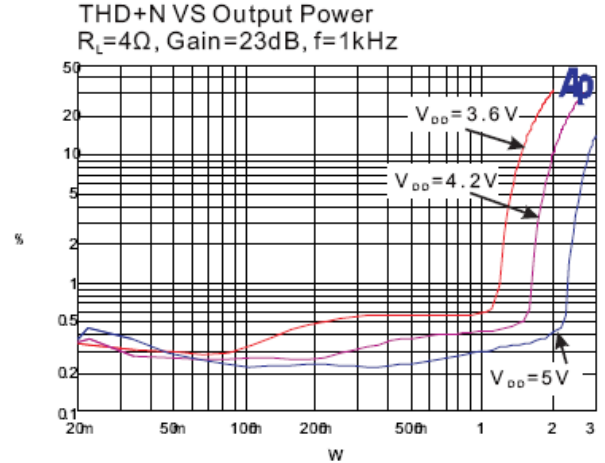
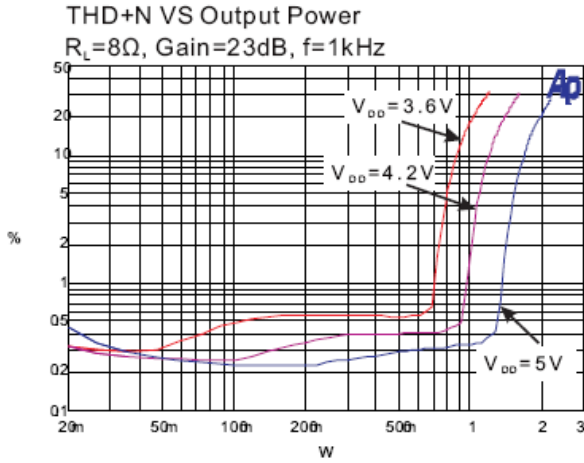

Typical Performance Characteristics (Continued) (@T_A = +25°C, unless otherwise specified.)

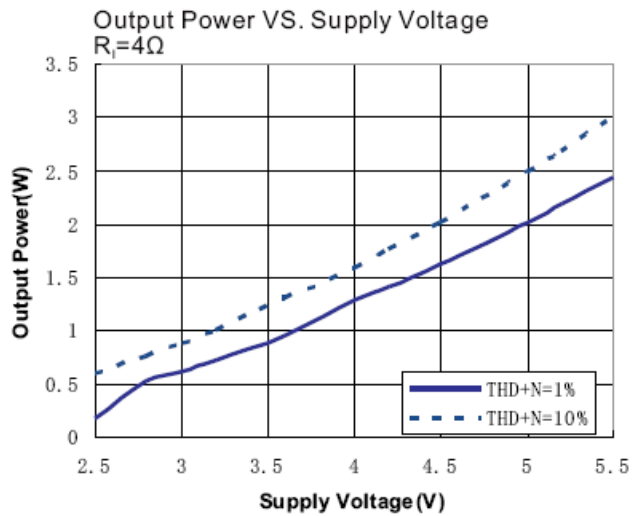
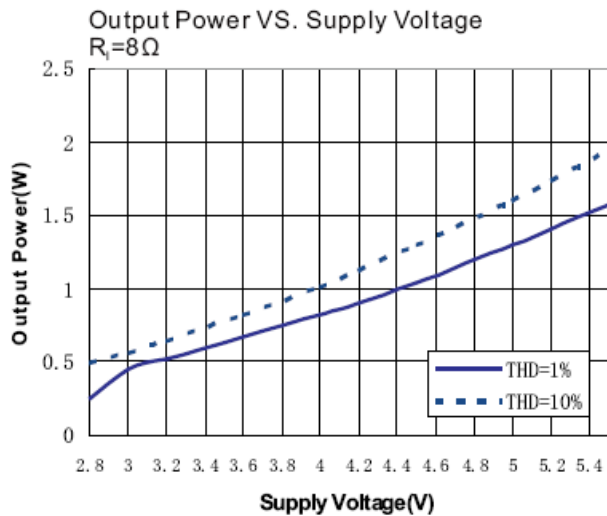
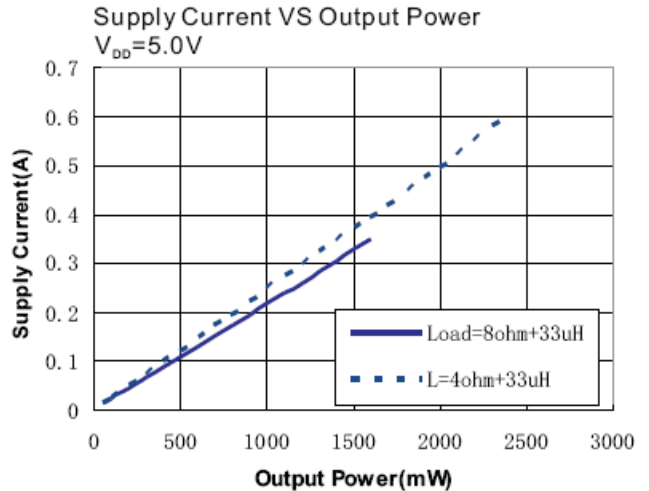
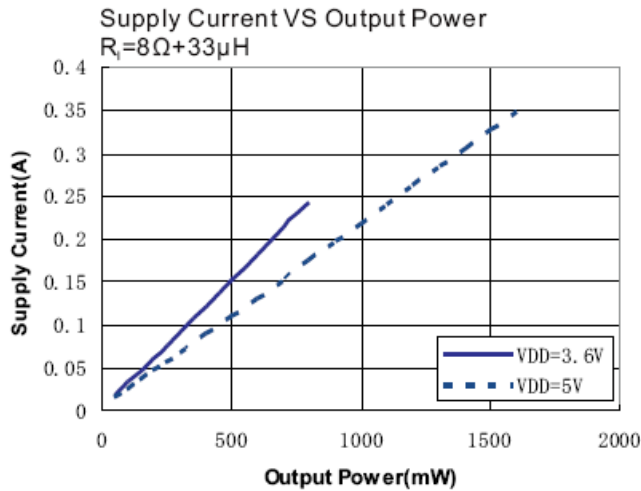
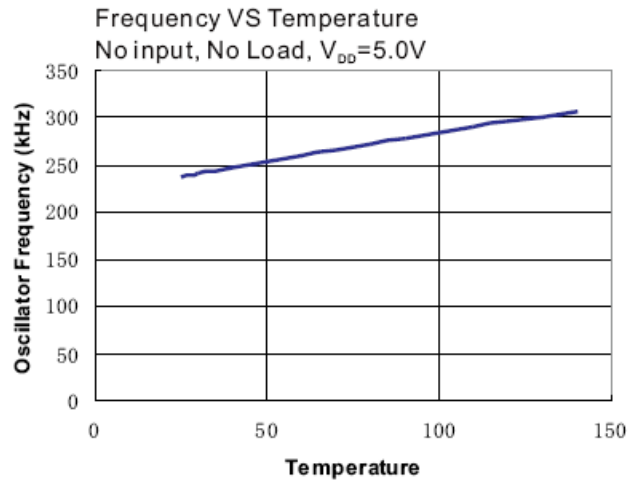
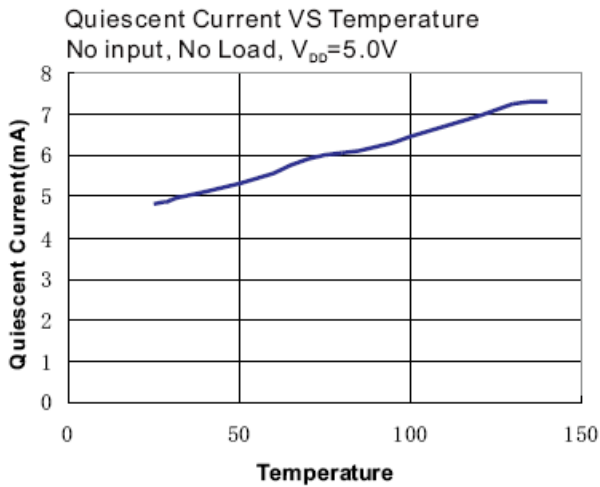

Typical Performance Characteristics (Cont.) (@T_A = +25°C, unless otherwise specified.)

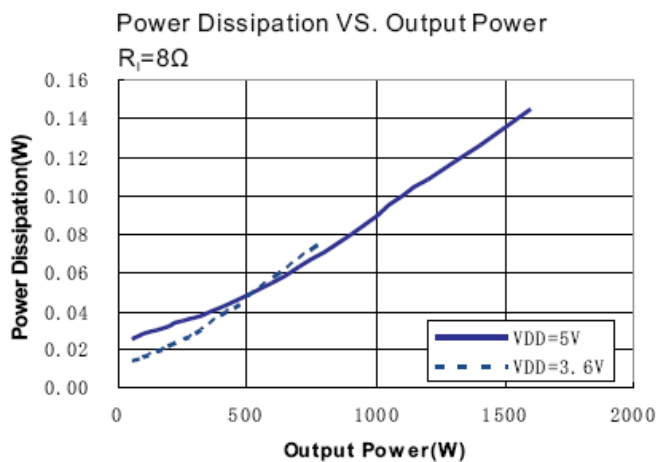
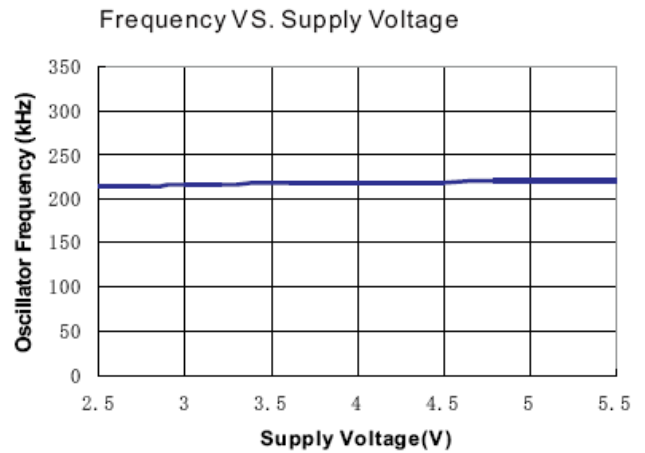
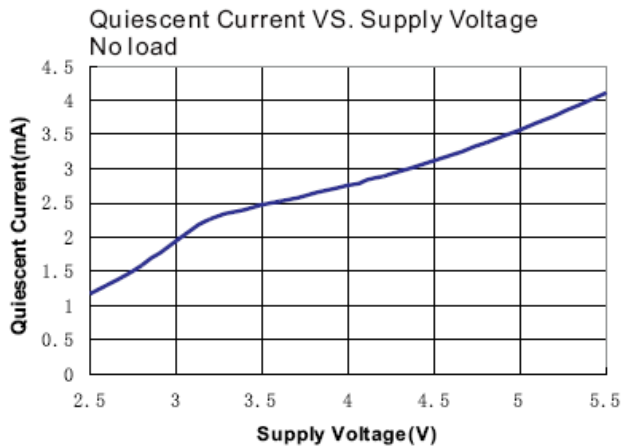
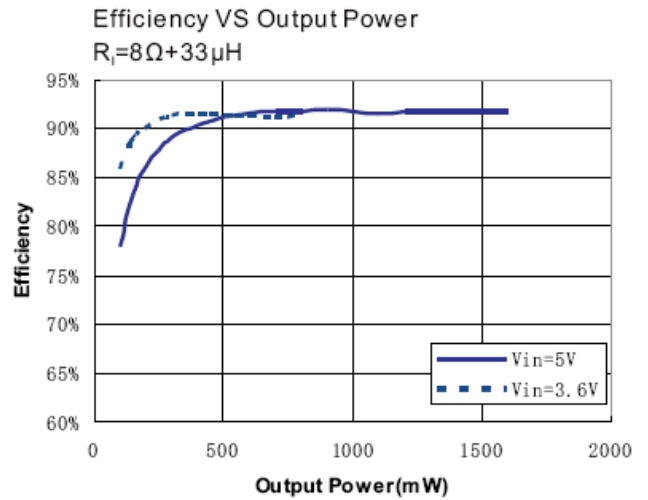
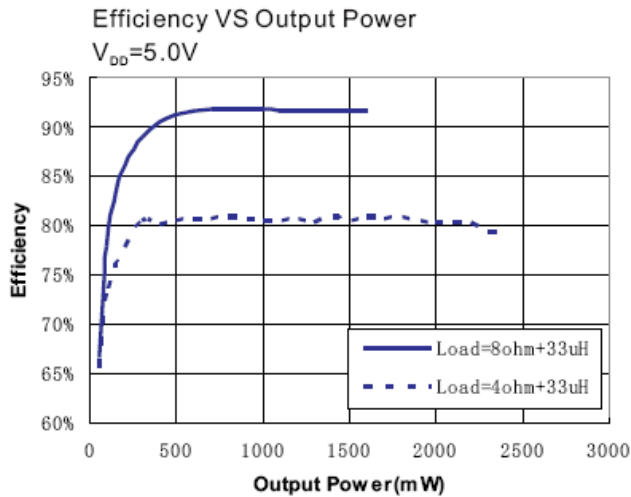

Application Information (Notes 4 & 5)

Test Setup for Performance Testing

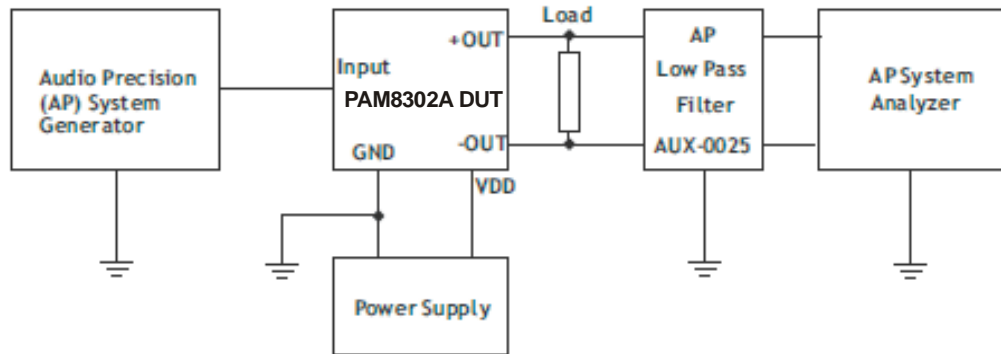

- Notes:
4. The AP AUX-0025 low pass filter is necessary for every class-D amplifier measurement with AP analyzer.
 5. Two 22μH inductors are used in series with load resistor to emulate the small speaker for efficiency measurement.

Maximum Gain

As shown in block diagram (Page 2), the PAM8302A has two internal amplifier stages. The first stage's gain is externally configurable, while the second stage's is internally fixed. The closed-loop gain of the first stage is set by selecting the ratio of R_F to R_I while the second stage's gain is fixed at 2x. The output of amplifier one serves as the input to amplifier two, thus the two amplifiers produce signals identical in magnitude, but different in phase by 180°. Consequently, the differential gain for the IC is:

$$A = 20 \cdot \log [2 \cdot (R_F/R_I)]$$

The PAM8302A sets maximum $R_F = 80k\Omega$, minimum $R_I = 10k\Omega$, so the maximum closed-gain is 24dB.

Input Capacitor (C_I)

In typical application, an input capacitor, C_I is required to allow the amplifier to bias input signals to a proper DC level for optimum operation. In this case, C_I and the minimum input impedance R_I (10k internal) form a high pass filter with a corner frequency determined by the following equation:

$$f_C = \frac{1}{2\pi R_I C_I}$$

It is important to choose the value of C_I as it directly affects low frequency performance of the circuit, for example, when an application requires a flat bass response as low as 100Hz. Equation is reconfigured as follows:

$$C_I = \frac{1}{2\pi R_I f_I}$$

As the input resistance is variable, for the C_I value of 0.16μF, one should actually choose the C_I within the range of 0.1μF to 0.22μF. A further consideration for this capacitor is the leakage path from the input source through the input network (R_I , R_F , C_I) to the load. This leakage current creates a DC offset voltage at the input to the amplifier that reduces useful headroom, especially in high gain application. For this reason, a low leakage tantalum or ceramic capacitor is the best choice. When a polarized capacitor is used, the positive side of the capacitor should face the amplifier input in most applications as the DC level is held at $V_{DD}/2$, which is likely higher than the source DC level. Please note that it is important to confirm the capacitor polarity in the application.

Application Information (Continued)

Power Supply Decoupling (Cs)

The PAM8302A is a high-performance CMOS audio amplifier that requires adequate power supply decoupling to ensure the output THD and PSRR as low as possible. Power supply decoupling affects low frequency response. Optimum decoupling is achieved by using two capacitors of different types that target different types of noise on the power supply leads. For higher frequency transients, spikes, or digital hash on the line, a good low equivalent-series-resistance (ESR) ceramic capacitor, typical 1.0 μ F is good, placing it as close as possible to the device V_{DD} terminal. For filtering lower frequency noise signals, capacitor of 10 μ F or larger, closely located to near the audio power amplifier is recommended.

Shutdown Operation

In order to reduce shutdown power consumption, the PAM8302A contains shutdown circuitry for turn to turn off the amplifier. This shutdown feature turns the amplifier off when a logic low is applied on the \overline{SD} pin. By switching the shutdown pin over to GND, the PAM8302A supply current draw will be minimized in idle mode.

For the best power on/off pop performance, the amplifier should be set in the shutdown mode prior to power on/off operation.

Undervoltage Lockout (UVLO)

The PAM8302A incorporates circuitry to detect low on or off voltage. When the supply voltage drops to 2.1V or below, the PAM8302A goes into a state of shutdown, and the device comes out of its shutdown state to normal operation by reset the power supply or \overline{SD} pin.

How to Reduce EMI (Electro Magnetic Interference)

A simple solution is to put an additional capacitor 1000 μ F at power supply terminal for power line coupling if the traces from amplifier to speakers are short (< 20CM). Most applications require a ferrite bead filter as shown in Figure 1. The ferrite filter depresses EMI of around 1MHz and higher. When selecting a ferrite bead, choose one with high impedance at high frequencies and low impedance at low frequencies.

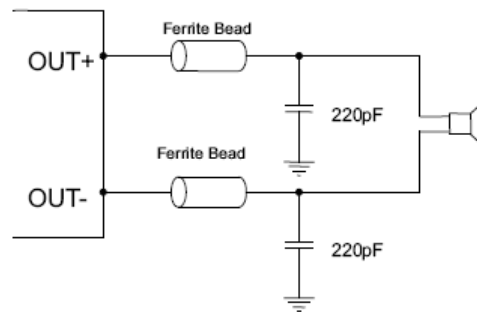
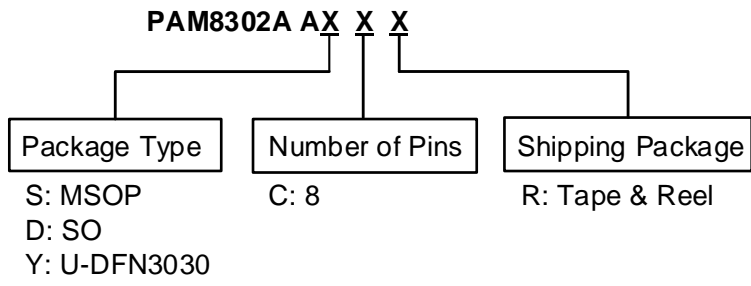

Figure 1 Ferrite Bead Filter to Reduce EMI

Ordering Information (Note 6)



Part Number	Package Type	Standard Package
PAM8302AASCR	MSOP-8	2,500 Units/Tape & Reel
PAM8302AADCR	SO-8	2,500 Units/Tape & Reel
PAM8302AAYCR	U-DFN3030-8	3,000 Units/Tape & Reel

Note: 6. For packaging details, go to our website at <http://www.diodes.com/products/packages.html>.

Marking Information

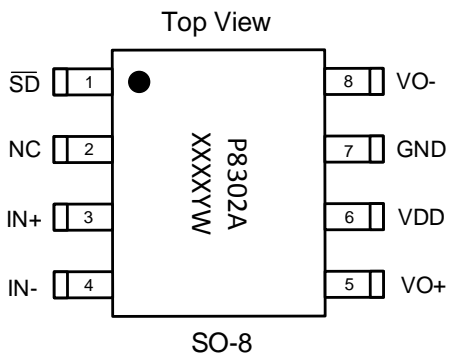

X : Internal Code
Y : Year
W : Week

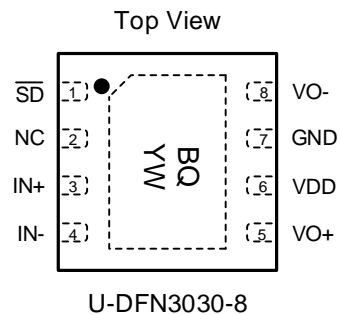

BQ : Product Code
Y : Year
W : Weekly

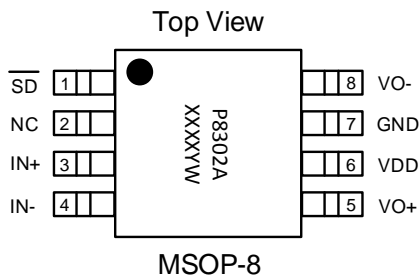

X : Internal Code
Y : Year
W : Week

Package Outline Dimensions

Please see <http://www.diodes.com/package-outlines.html> for the latest version.

MSOP-8

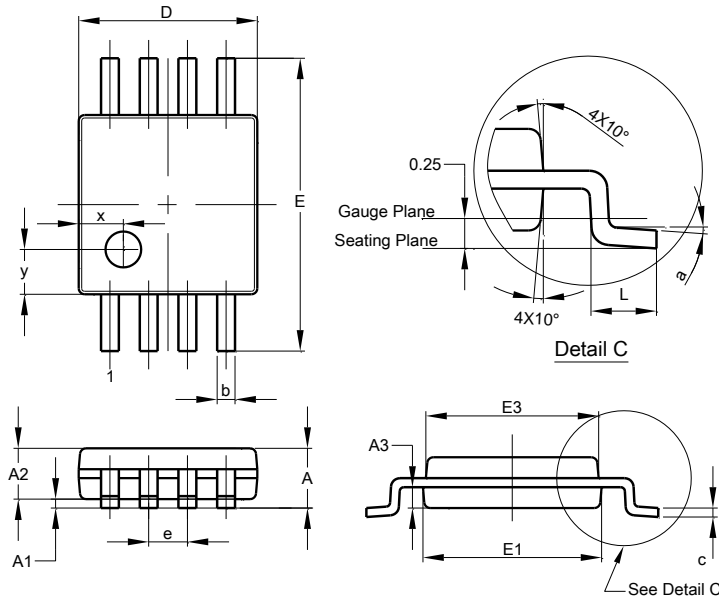

MSOP-8			
Dim	Min	Max	Typ
A	–	1.10	–
A1	0.05	0.15	0.10
A2	0.75	0.95	0.86
A3	0.29	0.49	0.39
b	0.22	0.38	0.30
c	0.08	0.23	0.15
D	2.90	3.10	3.00
E	4.70	5.10	4.90
E1	2.90	3.10	3.00
E3	2.85	3.05	2.95
e	–	–	0.65
L	0.40	0.80	0.60
a	0°	8°	4°
x	–	–	0.750
y	–	–	0.750

All Dimensions in mm

SO-8

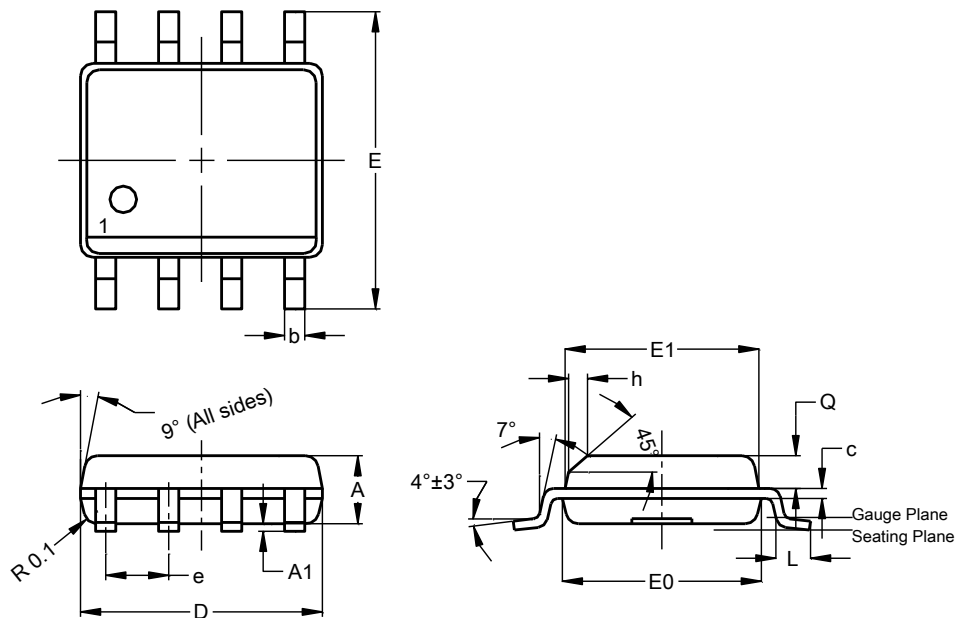

SO-8			
Dim	Min	Max	Typ
A	1.40	1.50	1.45
A1	0.10	0.20	0.15
b	0.30	0.50	0.40
c	0.15	0.25	0.20
D	4.85	4.95	4.90
E	5.90	6.10	6.00
E1	3.80	3.90	3.85
E0	3.85	3.95	3.90
e	–	–	1.27
h	–	–	0.35
L	0.62	0.82	0.72
Q	0.60	0.70	0.65

All Dimensions in mm

Package Outline Dimensions (Continued)

Please see <http://www.diodes.com/package-outlines.html> for the latest version.

U-DFN3030-8

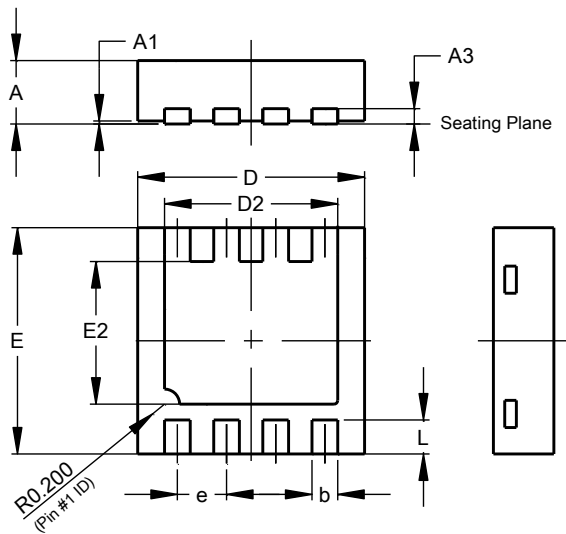

U-DFN3030-8			
Dim	Min	Max	Typ
A	0.57	0.63	0.60
A1	0	0.05	0.02
A3	–	–	0.15
b	0.29	0.39	0.34
D	2.90	3.10	3.00
D2	2.19	2.39	2.29
e	–	–	0.65
E	2.90	3.10	3.00
E2	1.64	1.84	1.74
L	0.30	0.60	0.45
All Dimensions in mm			

Suggested Pad Layout

Please see <http://www.diodes.com/package-outlines.html> for the latest version.

MSOP-8

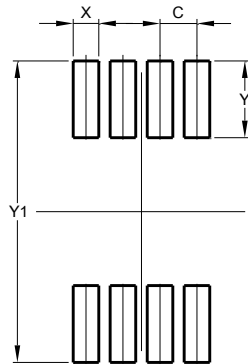

Dimensions	Value (in mm)
C	0.650
X	0.450
Y	1.350
Y1	5.300

SO-8

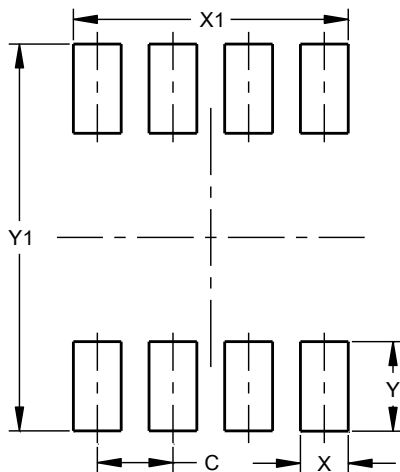

Dimensions	Value (in mm)
C	1.27
X	0.802
X1	4.612
Y	1.505
Y1	6.50

U-DFN3030-8

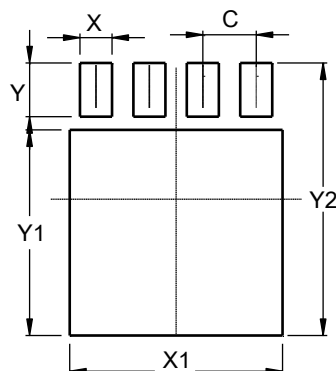

Dimensions	Value (in mm)
C	0.650
X	0.390
X1	2.590
Y	0.650
Y1	2.490
Y2	3.300

IMPORTANT NOTICE

DIODES INCORPORATED MAKES NO WARRANTY OF ANY KIND, EXPRESS OR IMPLIED, WITH REGARDS TO THIS DOCUMENT, INCLUDING, BUT NOT LIMITED TO, THE IMPLIED WARRANTIES OF MERCHANTABILITY AND FITNESS FOR A PARTICULAR PURPOSE (AND THEIR EQUIVALENTS UNDER THE LAWS OF ANY JURISDICTION).

Diodes Incorporated and its subsidiaries reserve the right to make modifications, enhancements, improvements, corrections or other changes without further notice to this document and any product described herein. Diodes Incorporated does not assume any liability arising out of the application or use of this document or any product described herein; neither does Diodes Incorporated convey any license under its patent or trademark rights, nor the rights of others. Any Customer or user of this document or products described herein in such applications shall assume all risks of such use and will agree to hold Diodes Incorporated and all the companies whose products are represented on Diodes Incorporated website, harmless against all damages.

Diodes Incorporated does not warrant or accept any liability whatsoever in respect of any products purchased through unauthorized sales channel. Should Customers purchase or use Diodes Incorporated products for any unintended or unauthorized application, Customers shall indemnify and hold Diodes Incorporated and its representatives harmless against all claims, damages, expenses, and attorney fees arising out of, directly or indirectly, any claim of personal injury or death associated with such unintended or unauthorized application.

Products described herein may be covered by one or more United States, international or foreign patents pending. Product names and markings noted herein may also be covered by one or more United States, international or foreign trademarks.

This document is written in English but may be translated into multiple languages for reference. Only the English version of this document is the final and determinative format released by Diodes Incorporated.

LIFE SUPPORT

Diodes Incorporated products are specifically not authorized for use as critical components in life support devices or systems without the express written approval of the Chief Executive Officer of Diodes Incorporated. As used herein:

A. Life support devices or systems are devices or systems which:

1. are intended to implant into the body, or
2. support or sustain life and whose failure to perform when properly used in accordance with instructions for use provided in the labeling can be reasonably expected to result in significant injury to the user.

B. A critical component is any component in a life support device or system whose failure to perform can be reasonably expected to cause the failure of the life support device or to affect its safety or effectiveness.

Customers represent that they have all necessary expertise in the safety and regulatory ramifications of their life support devices or systems, and acknowledge and agree that they are solely responsible for all legal, regulatory and safety-related requirements concerning their products and any use of Diodes Incorporated products in such safety-critical, life support devices or systems, notwithstanding any devices- or systems-related information or support that may be provided by Diodes Incorporated. Further, Customers must fully indemnify Diodes Incorporated and its representatives against any damages arising out of the use of Diodes Incorporated products in such safety-critical, life support devices or systems.

Copyright © 2016, Diodes Incorporated

www.diodes.com