



## HIGH ISOLATION SPDT NON-REFLECTIVE SWITCH, DC - 6 GHz

### Typical Applications

The HMC849ALP4CE is ideal for:

- Cellular/4G Infrastructure
- WiMAX, WiBro & Fixed Wireless
- Automotive Telematics
- Mobile Radio
- Test Equipment

### Features

- High Isolation: up to 60 dB
- Single Positive Control: 0/+3V to +5V
- High Input IP3: +52 dBm
- Non-Reflective Design
- “All Off” State
- 16 Lead 4x4 mm QFN Package: 16 mm<sup>2</sup>

### Functional Diagram

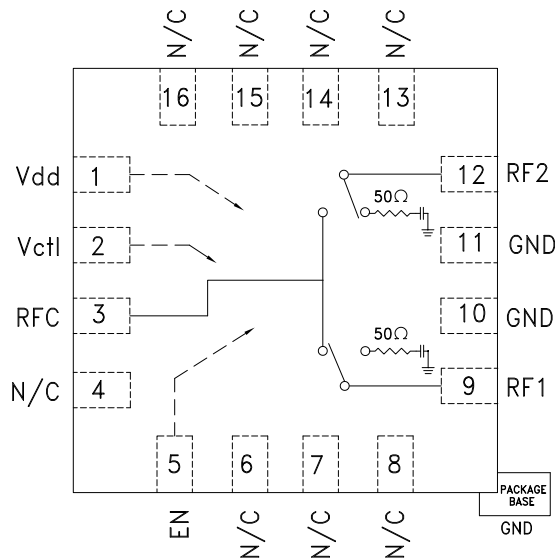

### General Description

The HMC849ALP4CE is a high isolation non-reflective DC to 6 GHz GaAs pHEMT SPDT switch in a low cost leadless surface mount package. The switch is ideal for cellular/WiMAX/4G Infrastructure applications yielding up to 60 dB isolation, low 0.8 dB insertion loss and +52 dBm input IP3. Power handling is excellent up through the 5 - 6 GHz WiMAX band with the switch offering a P1dB compression point of +31 dBm. On-chip circuitry allows a single positive voltage control of 0/+3V or 0/+5V at very low DC currents. An enable input (EN) set to logic high will put the switch in an “all off” state.

### Electrical Specifications, $T_A = +25\text{ }^\circ\text{C}$ , $V_{ctl} = 0/V_{dd}$ , $V_{dd} = +3V$ to $+5V$ , 50 Ohm System

Parameter	Frequency	Min.	Typ.	Max.	Units
Insertion Loss	DC - 2.0 GHz		0.9	1.3	dB
	2.0 - 4.0 GHz		1.0	1.5	dB
	4.0 - 6.0 GHz		1.8	2.5	dB
Isolation (RFC to RF1/RF2)	DC - 2.0 GHz	53	60		dB
	2.0 - 4.0 GHz	48	56		dB
	4.0 - 6.0 GHz	35	50		dB
Return Loss (On State)	DC - 4.0 GHz		17		dB
	4.0 - 6.0 GHz		14		dB
Return Loss (Off State)	DC - 6.0 GHz		15		dB
Input Power for 1 dB Compression	0.35 - 6.0 GHz	+3V	24	27	dBm
		+5V	30	33	dBm
Input Third Order Intercept (Two-Tone Input Power = +10 dBm Each Tone)	DC - 6.0 GHz		52		dBm
Switching Speed	DC - 6.0 GHz	tRISE, tFALL (10/90% RF)	60		ns
		tON, tOFF (50% CTL to 10/90% RF)	150	600	ns

# HMC849A\* PRODUCT PAGE QUICK LINKS

Last Content Update: 02/23/2017

---

## COMPARABLE PARTS

View a parametric search of comparable parts.

## EVALUATION KITS

- HMC849ALP4C Evaluation Board

## DOCUMENTATION

### Data Sheet

- HMC849A Data Sheet

## TOOLS AND SIMULATIONS

- HMC849A S-Parameter

## REFERENCE MATERIALS

### Quality Documentation

- HMC Legacy PDN: PCN130060
- Semiconductor Qualification Test Report: PHEMT-J (QTR: 2013-00285)

## DESIGN RESOURCES

- HMC849A Material Declaration
- PCN-PDN Information
- Quality And Reliability
- Symbols and Footprints

## DISCUSSIONS

View all HMC849A EngineerZone Discussions.

## SAMPLE AND BUY

Visit the product page to see pricing options.

## TECHNICAL SUPPORT

Submit a technical question or find your regional support number.

## DOCUMENT FEEDBACK

Submit feedback for this data sheet.

---



**HIGH ISOLATION SPDT  
NON-REFLECTIVE SWITCH, DC - 6 GHz**

**Insertion Loss**

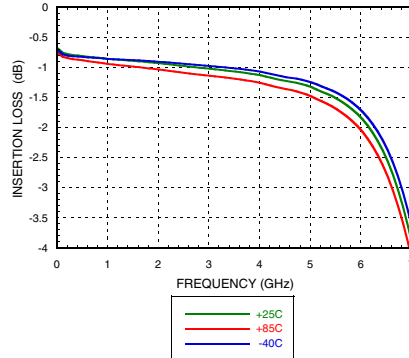

**Return Loss [1]**

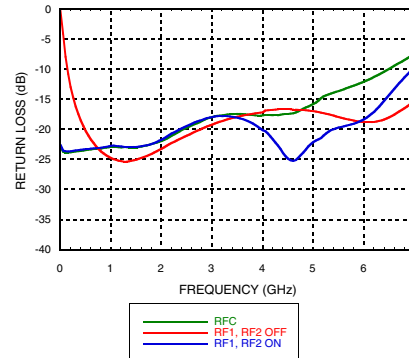

**Isolation Between  
Ports RFC and RF1 / RF2**

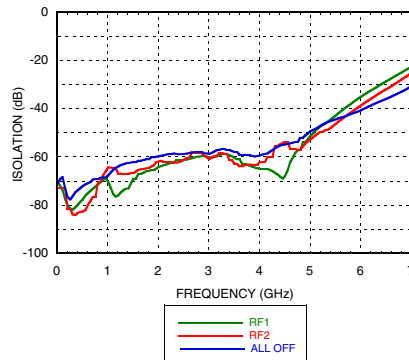

**Isolation Between Ports RF1 and RF2**

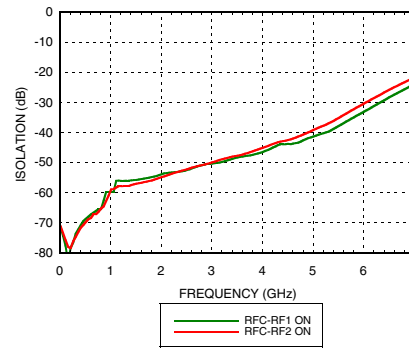

**0.1 and 1 dB Input Compression  
Point, Vdd = 5V, Linear**

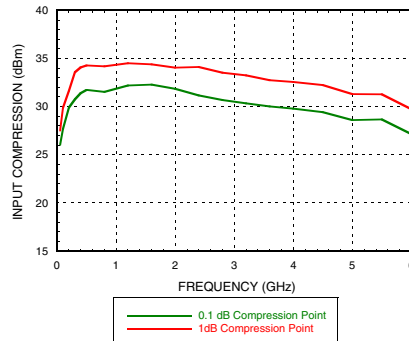

**0.1 and 1 dB Input Compression  
Point, Vdd = 3V, Linear**

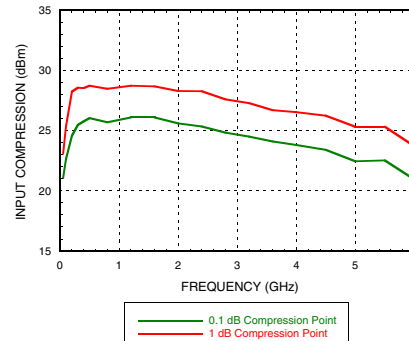

[1] RFC is reflective in "all off" state.



**HIGH ISOLATION SPDT  
NON-REFLECTIVE SWITCH, DC - 6 GHz**

SWITCHES - SPDT - SMT

**0.1 and 1 dB Input Compression Point, Vdd = 5V**

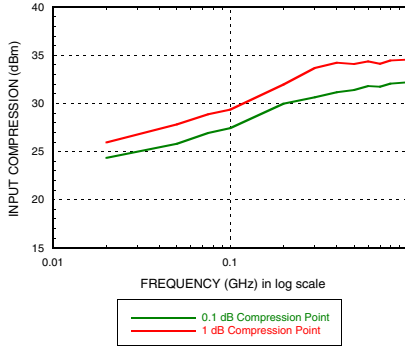

**0.1 and 1 dB Input Compression Point, Vdd = 3V**

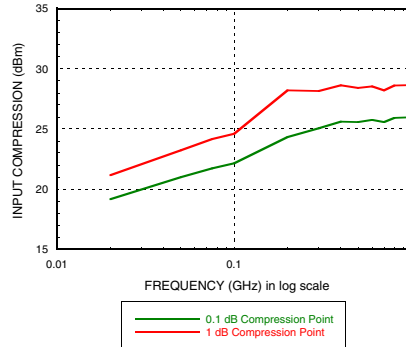

**Input Third Order Intercept Point, Vdd = 5V, Linear**

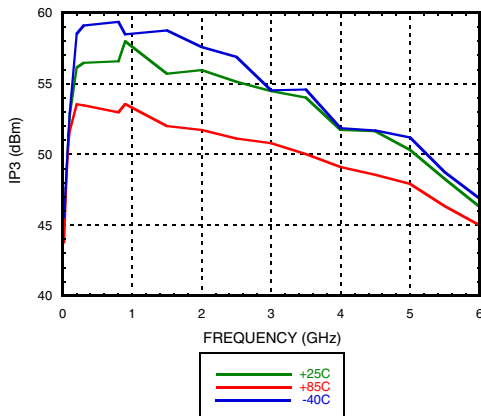

**Input Third Order Intercept Point, Vdd = 3V, Linear**

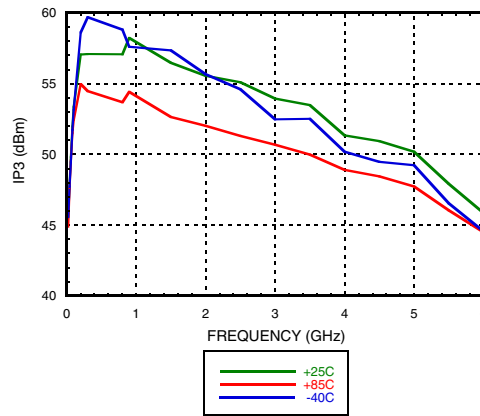

**Input Third Order Intercept Point, Vdd = 5V**

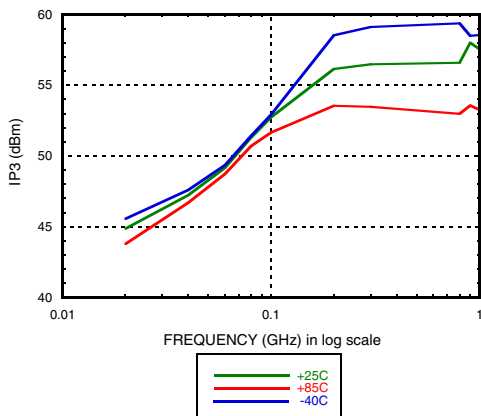

**Input Third Order Intercept Point, Vdd = 3V**

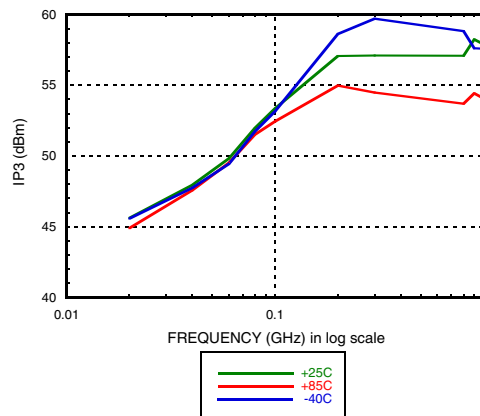

Information furnished by Analog Devices is believed to be accurate and reliable. However, no responsibility is assumed by Analog Devices for its use, nor for any infringements of patents or other rights of third parties that may result from its use. Specifications subject to change without notice. No license is granted by implication or otherwise under any patent or patent rights of Analog Devices. Trademarks and registered trademarks are the property of their respective owners.

For price, delivery, and to place orders: Analog Devices, Inc., One Technology Way, P.O. Box 9106, Norwood, MA 02062-9106 Phone: 781-329-4700 • Order online at [www.analog.com](http://www.analog.com) Application Support: Phone: 1-800-ANALOG-D

**HIGH ISOLATION SPDT  
NON-REFLECTIVE SWITCH, DC - 6 GHz**
**Absolute Maximum Ratings**

Bias Voltage (Vdd)	7V
Control Voltage (Vctl, EN)	-1V to Vdd +1V
RF Input Power *	31 / 33 dBm Through Path 3V/5V Termination Path 3V/5V 26.5 dBm
Channel Temperature	150 °C
Continuous Pdiss (T = 85 °C) (derate 14.9 mW/°C for through path, and 6.9 mW/°C for termination path above 85 °C)	0.969 W Through Path 0.451 W Termination Path
Thermal Resistance (channel to package bottom)	67.1 °C/W Through Path 144.2°C/W Termination Path
Storage Temperature	-65 to +150 °C
Operating Temperature	-40 to +85 °C
ESD Sensitivity (HBM)	Class 1A

\* The RF input power is quite lower than the breakdown power levels. Hence, the only concern with this product is the thermal limit.



**ELECTROSTATIC SENSITIVE DEVICE  
OBSERVE HANDLING PRECAUTIONS**

**Bias Voltage & Current**

Vdd (V)	Idd (Typ.) (mA)
3	1.2
5	1.3

**Digital Control Voltages**

State	Bias Condition
Low	0 to +0.8 Vdc @ <1 μA Typical
High	+2.0 to +5.0 Vdc @ 40 μA Typical

**Truth Table**

Control Input		Signal Path State	
Vctl	EN	RFC - RF1	RFC - RF2
Low	Low	OFF	ON
High	Low	ON	OFF
Low	High	OFF	OFF
High	High	OFF	OFF



**HIGH ISOLATION SPDT  
NON-REFLECTIVE SWITCH, DC - 6 GHz**

**Outline Drawing**

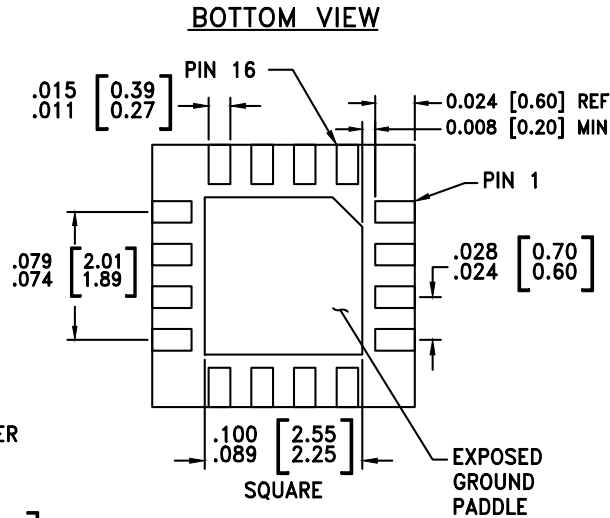
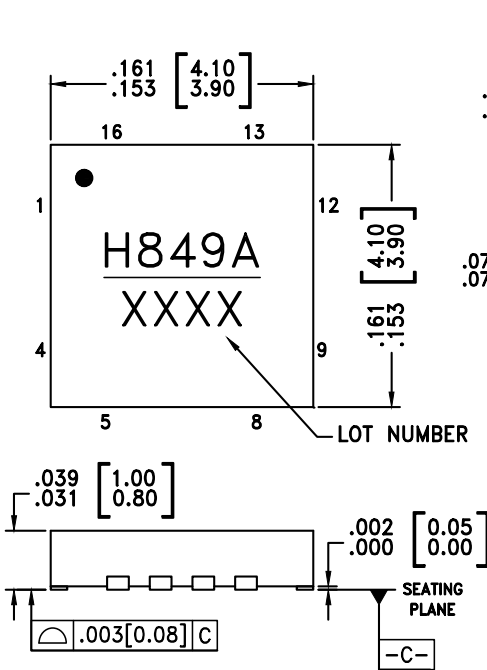

**NOTES:**

1. LEADFRAME MATERIAL: COPPER ALLOY
2. DIMENSIONS ARE IN INCHES [MILLIMETERS]
3. LEAD SPACING TOLERANCE IS NON-CUMULATIVE.
4. PAD BURR LENGTH SHALL BE 0.15mm MAXIMUM.  
PAD BURR HEIGHT SHALL BE 0.05mm MAXIMUM.
5. PACKAGE WARP SHALL NOT EXCEED 0.05mm.
6. ALL GROUND LEADS AND GROUND PADDLE MUST BE SOLDERED TO PCB RF GROUND.
7. REFER TO HITTITE APPLICATION NOTE FOR SUGGESTED LAND PATTERN.

**Package Information**

Part Number	Package Body Material	Lead Finish	MSL Rating	Package Marking <sup>[1]</sup>
HMC849ALP4CE	RoHS-compliant Low Stress Injection Molded Plastic	100% matte Sn	MSL1 <sup>[2]</sup>	H849A XXXX

[1] 4-Digit lot number XXXX

[2] Max peak reflow temperature of 260 °C



**HIGH ISOLATION SPDT  
NON-REFLECTIVE SWITCH, DC - 6 GHz**

**Pin Descriptions**

Pin Number	Function	Description	Interface Schematic
1	Vdd	Supply Voltage.	
2	Vctl	Control input. See truth and control voltage tables.	
3, 9, 12	RFC, RF1, RF2	These pins are DC coupled and matched to 50 Ohms. Blocking capacitors are required.	
4, 6, 7, 8, 13, 14, 15, 16	N/C	The pins are not connected internally; however, all data shown herein was measured with these pins connected to RF/DC ground externally.	
5	EN	Enable. See truth and control voltage tables.	
10, 11	GND	Package bottom must also be connected to PCB RF ground.	

**Application Circuit**

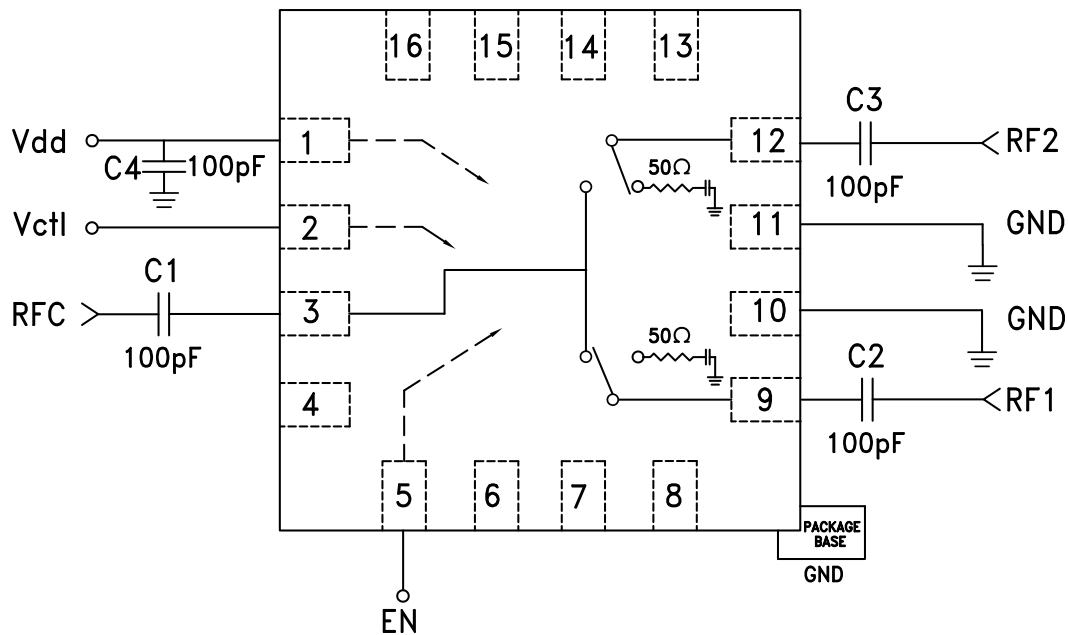

Information furnished by Analog Devices is believed to be accurate and reliable. However, no responsibility is assumed by Analog Devices for its use, nor for any infringements of patents or other rights of third parties that may result from its use. Specifications subject to change without notice. No license is granted by implication or otherwise under any patent or patent rights of Analog Devices. Trademarks and registered trademarks are the property of their respective owners.

For price, delivery, and to place orders: Analog Devices, Inc., One Technology Way, P.O. Box 9106, Norwood, MA 02062-9106 Phone: 781-329-4700 • Order online at [www.analog.com](http://www.analog.com) Application Support: Phone: 1-800-ANALOG-D



**HIGH ISOLATION SPDT  
NON-REFLECTIVE SWITCH, DC - 6 GHz**

**Evaluation PCB**

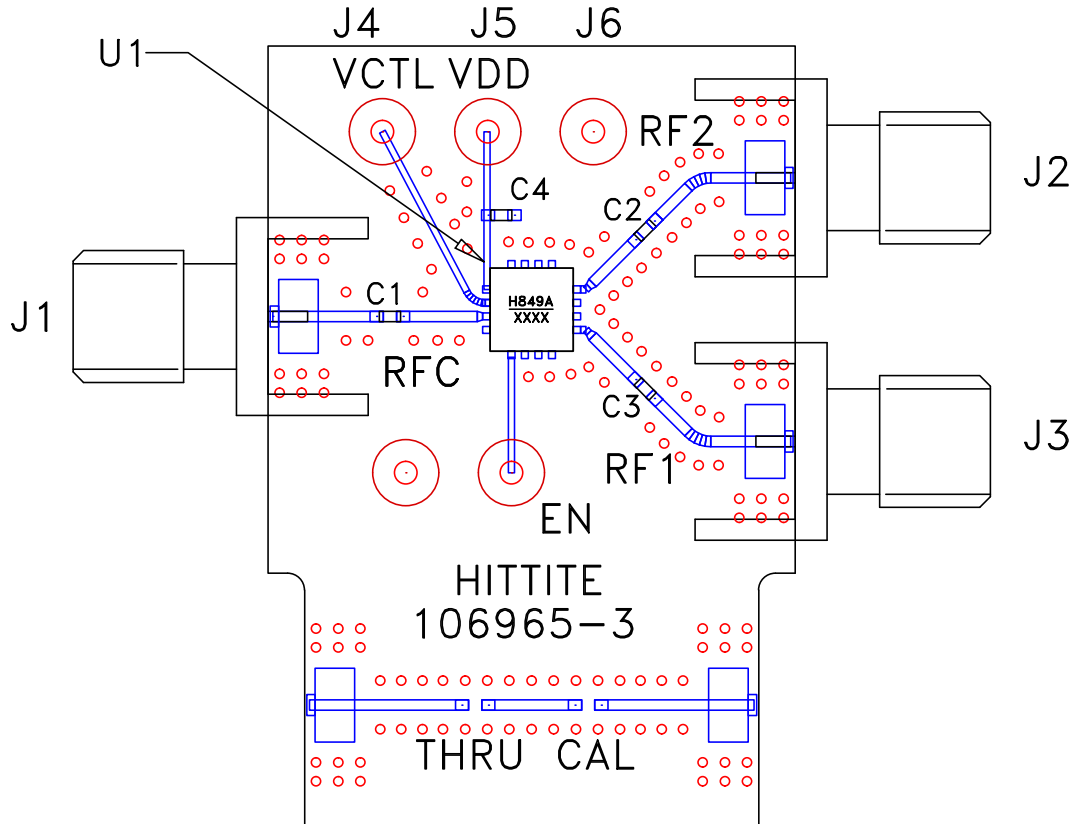

**List of Materials for Evaluation PCB EV1HMC849ALP4C [1]**

Item	Description
J1 - J3	PC Mount SMA RF Connector
J4 - J8	DC Pin
C1 - C4	100 pF Capacitor, 0402 Pkg.
U1	HMC849ALP4CE SPDT Switch
PCB [2]	106965 Evaluation PCB

[1] Reference this number when ordering complete evaluation PCB

[2] Circuit Board Material: Rogers 4350 or Arlon 25FR

The circuit board used in the final application should be generated with proper RF circuit design techniques. Signal lines at the RF port should have 50 Ohm impedance and the package ground leads and backside ground slug should be connected directly to the ground plane similar to that shown above. The evaluation circuit board shown above is available from Hittite Microwave Corporation upon request.



**Notes:****HMC849ALP4CE**

v00.1013

**HIGH ISOLATION SPDT  
NON-REFLECTIVE SWITCH, DC - 6 GHz**