

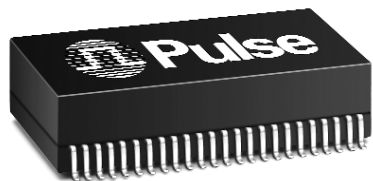





T1/CEPT/ISDN-PRI TRANSFORMER

Quad Port SMT Transformer Module with Line Side Protection



-  Four transmit transformers, four receive transformers and line side protection circuit in a surface mount package
-  Extended temperature range
-  Patented "Interlock Base" construction for high reliability
-  IC grade transfer-molded package withstands 235°C IR reflow temperature
-  Minimum Isolation voltage: 1500 Vrms
-  UL recognized

Electrical Specifications @ 25°C — Operating Temperature -40°C to +85°C

Part Number	Turns Ratio (Pri:Sec ±2%)		OCL Line Side (mH MIN)	Cw/w (pF MAX)	LL (µH MAX)	Package/ Schematic	Primary Pins	
	Transmit	Receive					Transmit	Receive
TX9032	1CT:1	1:1CT	1.2	35 & 35	.80 & .80	BRT	4-6, 10-12, 16-18, 22-24	48-46, 42-40, 36-34, 30-28
TX9033	1CT:1.14	1.14:1CT	1.2	35 & 35	1.0 & 1.0	BRT	4-6, 10-12, 16-18, 22-24	48-46, 42-40, 36-34, 30-28

Mechanical

Schematic

BRT

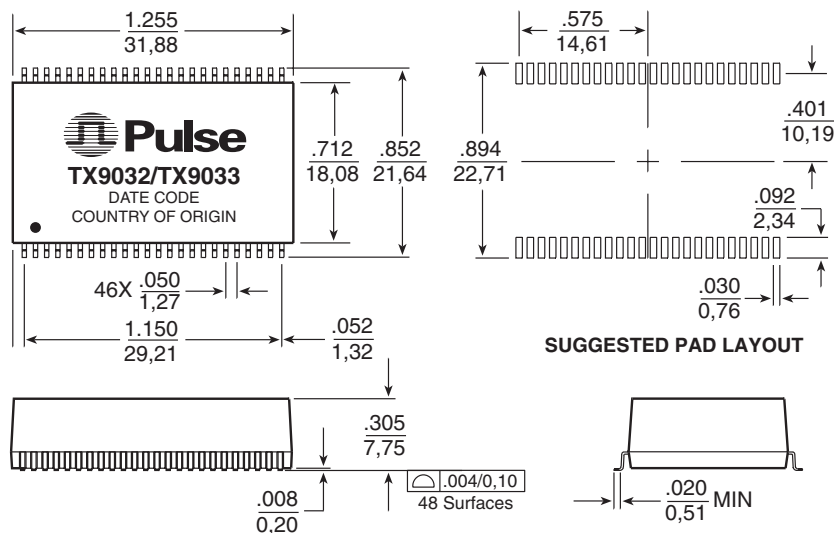

Weight9.2 grams
Tape & Reel150/reel
Tube15/tube

Dimensions: Inches
mm
Unless otherwise specified, all tolerances are ± .010
0,25

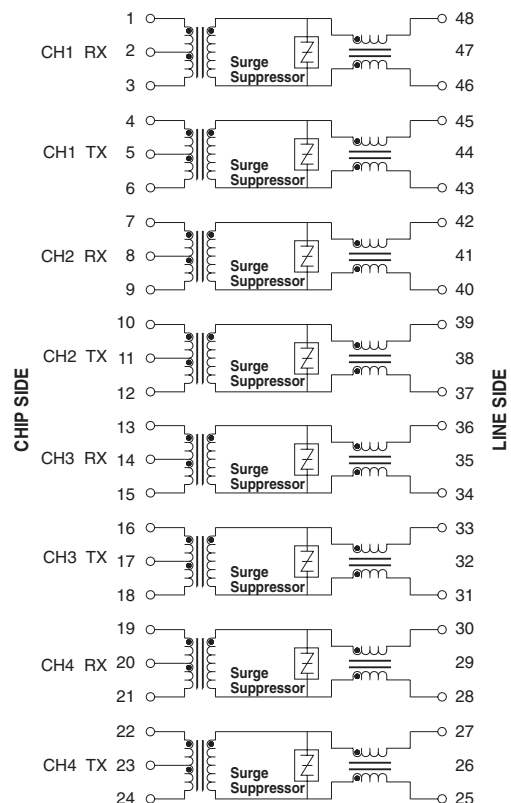

For More Information:

Pulse Worldwide Headquarters
12220 World Trade Drive
San Diego, CA 92128
U.S.A.
www.pulseeng.com
TEL: 858 674 8100
FAX: 858 674 8262

Pulse Northern Europe
3 Huxley Road
Surrey Research Park
Guildford, Surrey GU2 5RE
United Kingdom
TEL: 44 1483 401700
FAX: 44 1483 401701

Pulse Southern Europe
Zone Industrielle
F-39270
Orgelet
France
TEL: 33 3 84 35 04 04
FAX: 33 3 84 25 46 41

Pulse China Headquarters
No. 1
Industrial District
Changan, Dongguan
China
TEL: 86 769 85538070
FAX: 86 769 85538870

Pulse North China
Room 1503
XinYin Building
No. 888 YiShan Road
Shanghai 200233
China
TEL: 86 21 54643211/2
FAX: 86 21 54643210

Pulse South Asia
150 Kampong Ampat
#07-01/02
KA Centre
Singapore 368324
TEL: 65 6287 8998
FAX: 65 6280 0080

Pulse North Asia
No. 26
Kao Ching Road
Yang Mei Chen
Taoyuan Hsien
Taiwan, R. O. C.
TEL: 886 3 4641811
FAX: 886 3 4641911

Performance warranty of products offered on this data sheet is limited to the parameters specified. Data is subject to change without notice. Other brand and product names mentioned herein may be trademarks or registered trademarks of their respective owners.

© Copyright, 2006. Pulse Engineering, Inc. All rights reserved.

www.pulseeng.com

T680.A (5/06)